



Cambridge International Examinations
Cambridge International General Certificate of Secondary Education

CANDIDATE
NAME

CENTRE
NUMBER

--	--	--	--	--

CANDIDATE
NUMBER

--	--	--	--

* 0 1 2 3 4 5 6 7 8 9 *



PHYSICS

0625/03

Paper 3 Theory (Core)

For Examination from 2016

SPECIMEN PAPER

1 hour 15 minutes

Candidates answer on the Question Paper.

No Additional Materials are required.

READ THESE INSTRUCTIONS FIRST

Write your Centre number, candidate number and name on all the work you hand in.

Write in dark blue or black pen.

You may use an HB pencil for any diagrams, graphs or rough working.

Do not use staples, paper clips, glue or correction fluid.

DO **NOT** WRITE IN ANY BARCODES.

Answer **all** questions.

Electronic calculators may be used.

You may lose marks if you do not show your working or if you do not use appropriate units.

Take the weight of 1.0 kg to be 10 N (acceleration of free fall = 10 m/s^2).

At the end of the examination, fasten all your work securely together.

The number of marks is given in brackets [] at the end of each question or part question.

The syllabus is accredited for use in England, Wales and Northern Ireland as a Cambridge International Level 1/Level 2 Certificate.

This document consists of **20** printed pages.

1 Fig. 1.1 shows how the speed of an object varies during a period of 30 s.

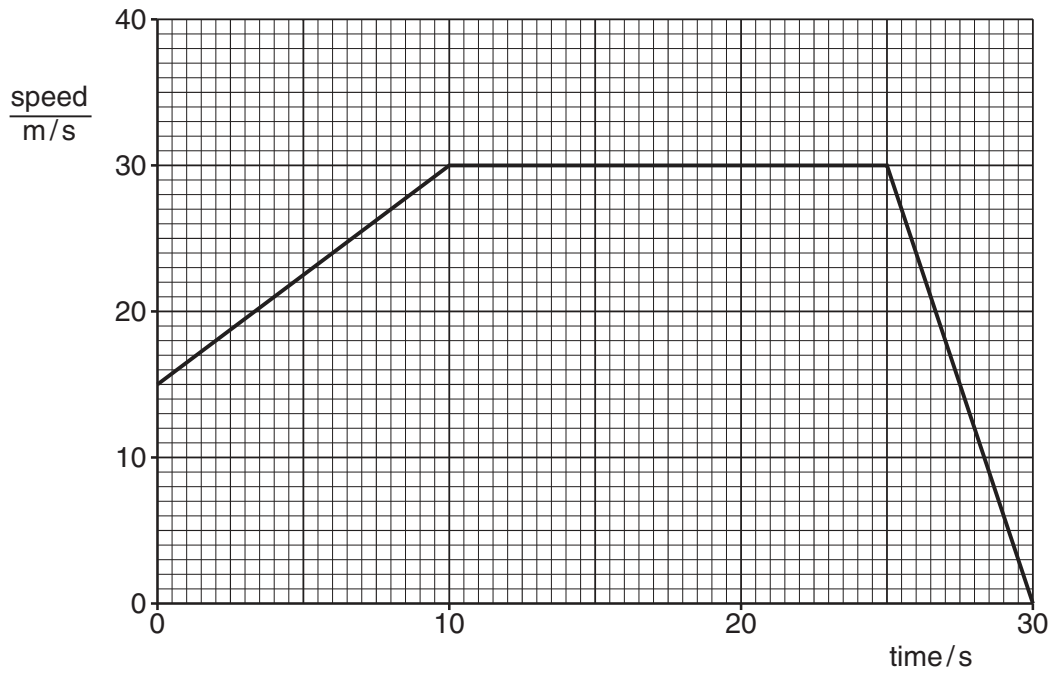

Fig. 1.1

(a) State the speed of the object

(i) at the start, time = 0 s,

speed = m/s

(ii) at the end, time = 30 s.

speed = m/s
[2]

(b) Describe what, if anything, is happening to the speed during the period 10 s to 25 s.

..... [1]

(c) Determine the distance travelled in the last 5 s.

distance = m [3]

(d) The total distance travelled during the 30 s is 750 m.

Calculate the average speed of the object during the 30 s.

average speed = m/s [3]

[Total: 9]

2 The car in Fig. 2.1 is on a level road.



Fig. 2.1

(a) Calculate the magnitude of the resultant force on the car.

resultant force = N [1]

(b) Tick the box below that describes the motion of the car.

- travels forward at constant speed
- travels forward with increasing speed
- travels forward with decreasing speed
- travels backward at constant speed
- travels backward with increasing speed
- travels backward with decreasing speed
- remains at rest

[1]

(c) Later, the car is moving forwards and the frictional forces suddenly increase to 2500 N. The forwards force remains constant at 2000 N.

Describe and explain what happens to the car.

.....
 [2]

(d) Suggest what might have caused the frictional forces in (c) to increase.

..... [1]

[Total: 5]

- 3 (a) In a laboratory experiment to find the centre of mass of a triangular piece of plastic, the plastic is freely suspended first from point A and then from point B, as shown in Figs. 3.1 and 3.2.

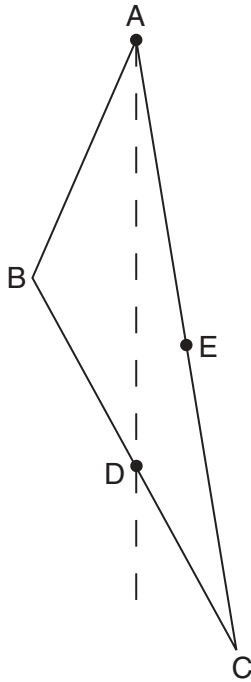

Fig. 3.1

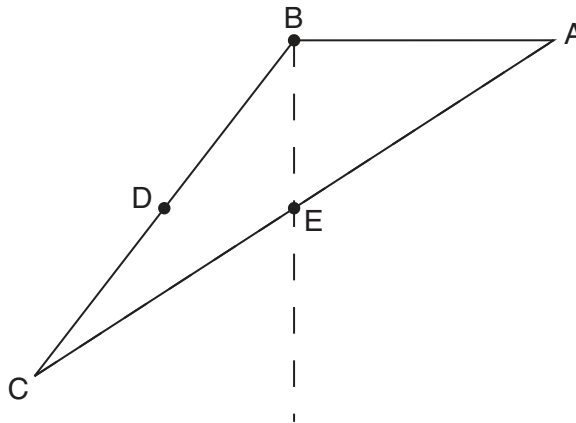

Fig. 3.2

When suspended from point A, point D is found to be vertically below A.

When suspended from point B, point E is vertically below B.

- (i) What piece of apparatus might be used to determine the vertical lines from A and from B?

..... [1]

- (ii) On Fig. 3.3 below, draw construction lines to find the position of the centre of mass of the piece of plastic. Label this point clearly with the letter G.

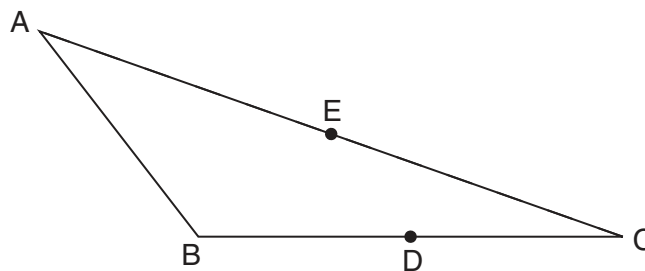

Fig. 3.3

[2]

(b) The piece of plastic has a mass of 120 g.

Calculate the weight of the piece of plastic.

weight = N [3]

[Total: 6]

- 4 (a) State what is meant by the *moment* of a force.

.....
 [1]

- (b) A warehouse worker is about to close a large door, as shown in Fig. 4.1.

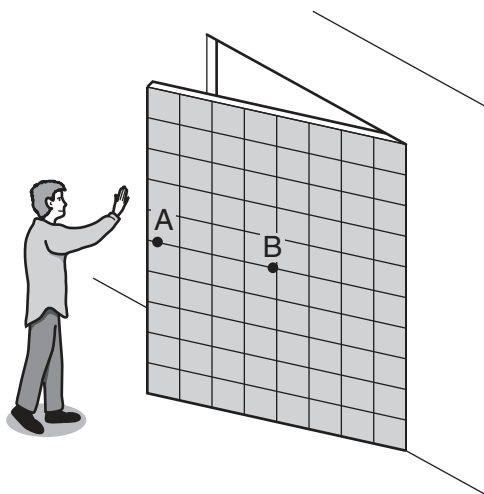

Fig. 4.1

- (i) State, with a reason, which of the two positions, A or B, will enable him to close the door with least force.

.....
 [1]

- (ii) On another occasion, with the door in the position shown in Fig. 4.1, two workers each push on the door with the same force at the same time. One worker pushes at A, from the side seen in Fig. 4.1. The other worker pushes at B, from the other side of the door.

Which way does the door move, if at all? Tick one box.

- the door closes
 the door opens
 the door remains in the same position

[1]

[Total: 3]

- 5 A student gently heats a sample of solid wax in a test-tube, as shown in Fig. 5.1. The temperature of the wax is measured every minute.

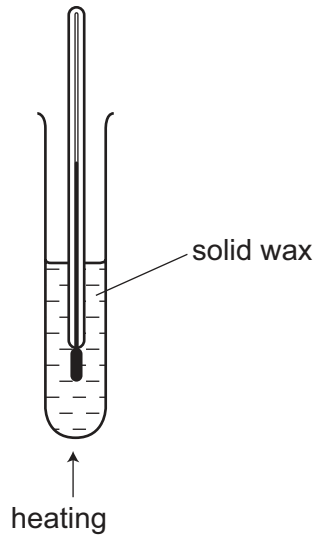

Fig. 5.1

- (a) Describe the structure of the solid wax in terms of the arrangement and motion of the wax molecules.

.....

 [2]

- (b) The student's data is shown below.

time / minutes	0	1	2	3	4	5	6	7	8	9	10
temperature / °C	35	40	45	49	50	50	50	50	50	53	56

Use the data to describe and explain what is happening to the wax during this period.

.....

 [5]

[Total: 7]

6 The owner of a small factory suggests installing a wind turbine to generate some of the electricity needed by the factory.

(a) Give one environmental reason for using a wind turbine.

..... [1]

(b) Discuss **three** of the factors that the owner will need to consider when deciding whether to install a wind turbine.

.....
.....
.....
.....
.....
.....
..... [4]

[Total: 5]

7 Fig. 7.1 shows a stationary pole vaulter holding a straight pole. Fig. 7.2 shows him during the vault with the pole bent.

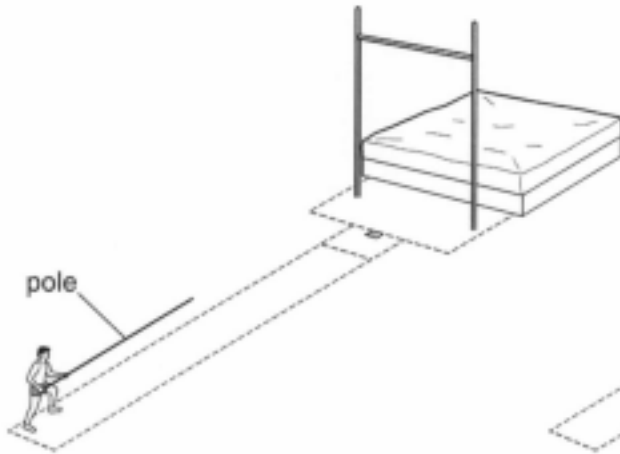

Fig. 7.1

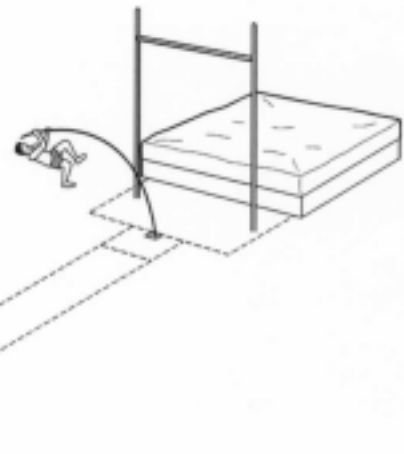

Fig. 7.2

(a) Identify the energy changes that have taken place, for the pole vaulter and for the pole, between the situations shown in Figs. 7.1 and 7.2. State the evidence for these changes.

.....
.....
.....
.....
.....
..... [4]

(b) The pole vaulter releases the pole and clears the bar.

Explain how the principle of conservation of energy applies as he falls from his maximum height.

.....
.....
..... [2]

[Total: 6]

- 8 A man looks at his reflection in a vertical mirror. This is shown from the side in Fig. 8.1.



Fig. 8.1

- (a) On Fig. 8.1, accurately mark with a **clear cross** where the image of the tip **A** of the man's beard will be. Label the cross **B**. [2]
- (b) On Fig. 8.1, accurately draw a ray from the tip of the man's beard that reflects from the mirror and goes into his eye. Use arrows to show the direction of the ray. [2]
- (c) On Fig. 8.1, mark the angles of incidence and reflection at the mirror using the letters i and r . [1]

[Total: 5]

- 9 Fig. 9.1 represents the regions of the electromagnetic spectrum.

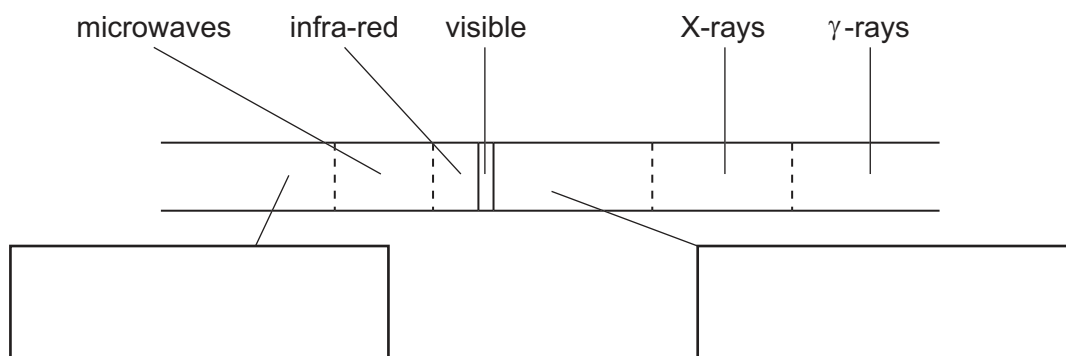

Fig. 9.1

- (a) Two of the regions have not been named in Fig. 9.1.

In the two boxes below the spectrum, write the names of these regions. [2]

- (b) Write "long wavelength" next to the long wavelength end of the electromagnetic spectrum. [1]

- (c) State one use for the radiation of each of the following regions.

infra-red

gamma-rays

[2]

[Total: 5]

10 (a) A student connects the circuit shown in Fig. 10.1.

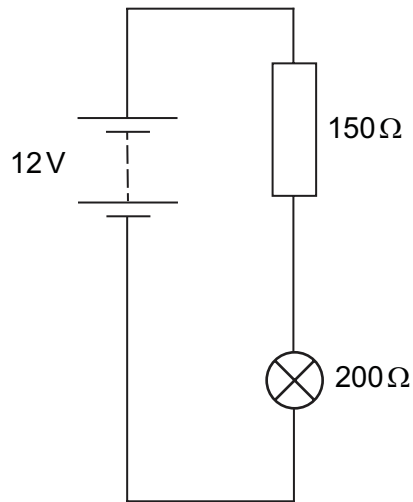

Fig. 10.1

(i) Calculate the current in the circuit.

current = [4]

(ii) Calculate the potential difference (p.d.) across the lamp.

p.d. = V [2]

(iii) Draw on Fig. 10.1 to suggest how the circuit may be modified so that the brightness of the lamp can be controlled. [1]

(b) The circuit is re-arranged as shown in Fig. 10.2.

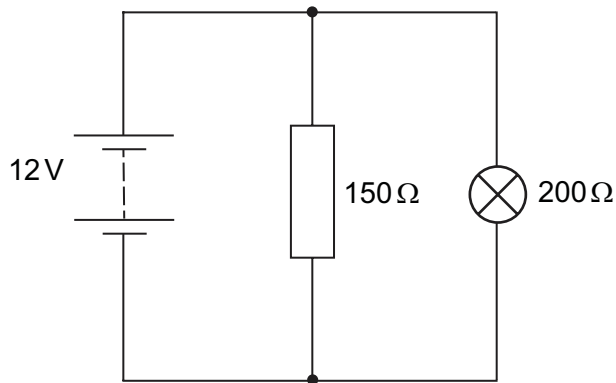

Fig. 10.2

(i) What word is used to describe this new arrangement of the components?

..... [1]

(ii) Predict and explain how the brightness of the lamp compares to the lamp in Fig. 10.1.

.....

 [2]

[Total: 10]

11 (a) Fig. 11.1 represents a permanent magnet.



Fig. 11.1

- (i) Carefully draw on Fig. 11.1 to show the pattern and direction of magnetic field lines around the magnet. [2]
- (ii) What is an *electromagnet*? [1]

.....

.....

- (b) An iron bar has many turns of wire wrapped around it, as shown in Fig. 11.2. The wire is connected to an alternating current supply. Some more wire is made into a flat coil and connected across a low voltage lamp.

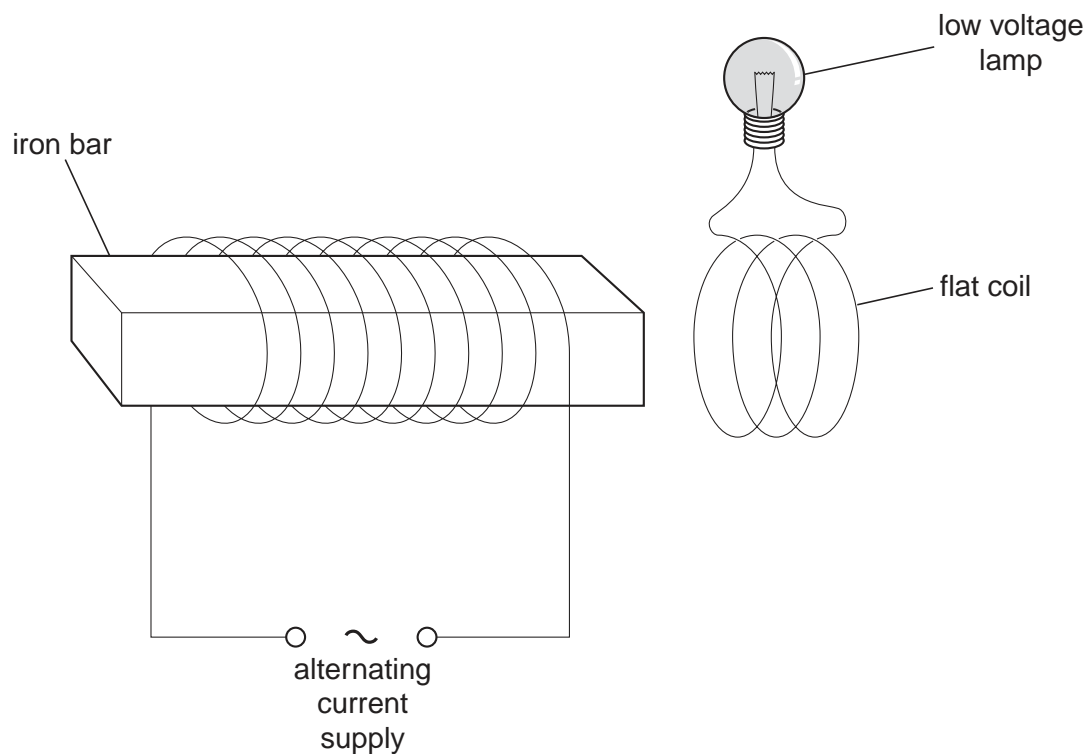

Fig. 11.2

- (i) Explain how alternating current (a.c.) is different from direct current (d.c.).

.....
 [1]

- (ii) When the flat coil is held close to the end of the iron bar, the lamp glows.

Explain why this happens.

.....

 [3]

[Total: 7]

12 (a) What is meant by *radioactive decay*?

.....
.....
..... [2]

(b) Fig. 12.1 shows two samples of the same radioactive substance. The substance emits β -particles.

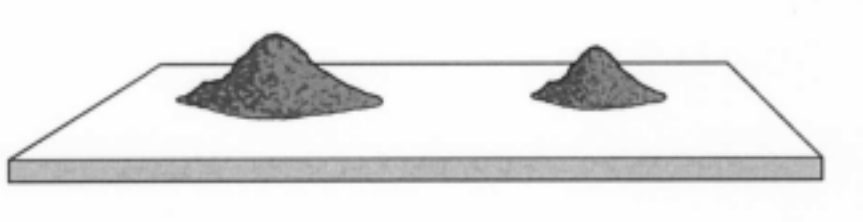

Fig. 12.1

Put a tick alongside any of the following quantities which is the same for both samples.

- the half-life
- the mass
- the number of atoms decaying each second
- the number of β -particles emitted each second

[1]

(c) Fig. 12.2 shows the decay curve for a particular radioactive substance.

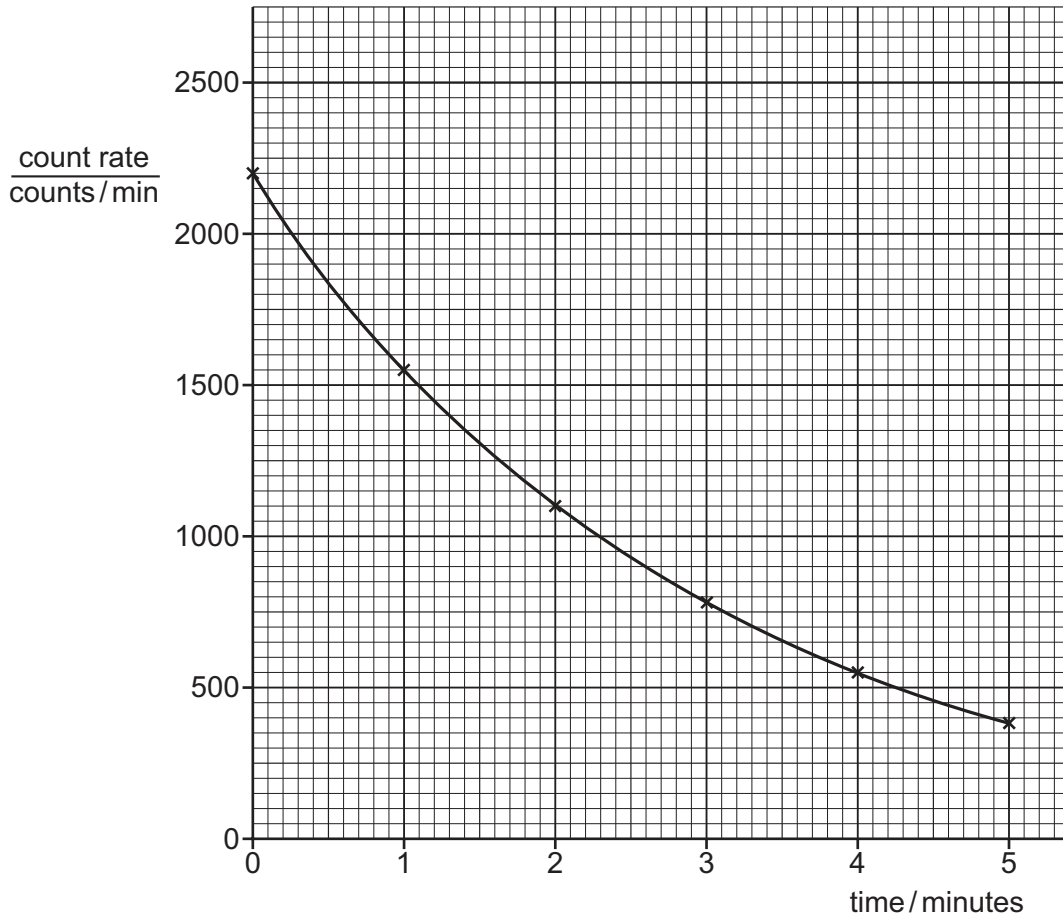

Fig. 12.2

(i) Select and use numbers from the graph to deduce the half-life of the radioactive substance.

half-life = minutes [3]

(ii) Predict the value of the count rate at a time of 6 minutes from the start of the measurements. Show your working.

count rate = counts/min [2]

(d) People handling radioactive substances need to take certain safety precautions.

(i) Explain why safety precautions are necessary.

.....
..... [2]

(ii) State **two** safety precautions used by people handling radioactive substances.

1.

2.

[2]

[Total: 12]

Permission to reproduce items where third-party owned material protected by copyright is included has been sought and cleared where possible. Every reasonable effort has been made by the publisher (UCLES) to trace copyright holders, but if any items requiring clearance have unwittingly been included, the publisher will be pleased to make amends at the earliest possible opportunity.

Cambridge International Examinations is part of the Cambridge Assessment Group. Cambridge Assessment is the brand name of University of Cambridge Local Examinations Syndicate (UCLES), which is itself a department of the University of Cambridge.